



Toprağınıza Uğurlu
Bereketi Gelsin

2026

FİYAT LİSTESİ // PRICELIST

Hakkımızda:

Uğurlu Yağmurlama San. ve Tic. Ltd. Şti. plastik makinaları ve kalıpları üretmek üzere, 2000 yılında Konya' da kuruldu. Sektörde AR-GE çalışmaları ile dikkatleri üzerine çeken firmamız, yağmurlama sulama sektörüne kattığı ürünlerle, yenilikleri izlenen öncü role sahip bir şirket olmuştur.

Kurucuları itibariyle, geniş sektör deneyimine sahip olan Uğurlu Yağmurlama, sektöre kattığı mühendislik değerleri, teknik kadrosu ve toplam kalite yönetimini benimsemiş insan kaynakları ile müşteri memnuniyeti ana hedef olarak benimsenmiştir.

Salt sanayi ve maliyet araştırmaları değil, son kullanıcı olan çiftçinin, faydasını öne alan AR-GE yi işletmenin en önemli değeri olarak gören Uğurlu Yağmurlama, her yıl yenilenen ürünlerine bir çok patent ve faydalı model almıştır.

Uğurlu Yağmurlama, bugün ülkemizde hızla markalaşan bir çok yağmurlama sulama boruları fabrikasının kurucu mühendisliğini taahhüt etmiş ve kurmuştur.



YAĞMURLAMA SULAMA SİSTEMLERİNİN FAYDALARI

- Yağmurlama sulama yöntemiyle topoğrafik yönden düzgün olmayan engebeli tarım alanları tesviyeye gerek kalmadan sulanabilir. Salma sulamaya bağlı erozyon önlenir.
- Su alma hızı yüksek ve su tutma kapasitesi düşük kumlu toraklarda karık akışına bağlı su kaybına neden olmaksızın tüm tarla alanında ekonomik ve dengeli olarak yüksek randımanla sulama yapılır.
- Taban suyunun yüksek olduğu yerlerde taban su seviyesine yükseltmeden sulama yapılır.
- Genellikle bitki sıra aralıklarına serildiğinden tarlanın ekim alanı artmakta, sulama işçilik masrafları azalmaktadır.
- Gübre sulama suyuyla bitkiye verilebildiğinden işçilikten tasarruf sağlanır.
- Sulama suyu araziye kontrollü olarak istenilen miktarda verildiğinden su kayıpları en aza indirilir.
- Ekonomik değerleri yüksek sebzeler, meyve ağaçları, bağlar dondan ve sıcaktan korunur.
- Bitki yapraklarında oluşan tuz ve toz zerreleri kolayca yıkanarak bitkiye zarar vermesi önlenir.



Toprağınıza **Uğurlu**
Bereketi Gelsin...

YAĞMURLAMA SULAMA DÜZENİNDE DİKKAT EDİLECEK HUSUSLAR

- Motopomp bağlantısında sonra motorun titreşiminin boru sistemine aktarılmasını önlemek için Es parça kullanılmalıdır.
- Ana boru hatları lateral borulara dik konumda olmalıdır.
- Lateral boru hatları mümkün olduğunca eğimsiz veya bayır aşağı döşenmelidir.
- Rüzgarın şiddetli estiği yerlerde lateraller rüzgar yönüne dik olacak şekilde döşenmelidir.
- Homojen bir sulama ve işçilikten tasarruf için tateral uzunluğu kısa tutulmalıdır.
- Sistemin düzeni, sistem maliyetini ve işçiliği en aza düşürecek şekilde yapılmalıdır.
- Boru ve parçalardaki conta yuvalarının temizliği kontrol edildikten sonra contalar takılmalı, daha sonrada birleştirme yapılmalıdır.
- Sistemin içine yabancı madde girmemesi için pompa emme borusunun ucuna filtre takılması gerekmektedir.
- Sistemin içine kaynaktan gelen su vasıtasıyla yabancı madde girmişse bu maddeler sistemin sonundaki kör tapaların bir süre açılmasıyla dışarı atılmalıdır.
- Sulama sezonu bittikten sonra sisteme ait olan bütün parçalar kurutulmalı, temizlenmeli ve stoğa alınmalıdır.





444 (S-40)
49,15 ₺

► (S-40) Performans Çizelgesi

Nozzle (mm)	Basınç (Bar)	Debi (m ³ /saat)	Çap (m)	Koli Adet
2.8 x 1.8	2.0	0.600	20	200
	3.0	0.800	24	200
3.5 x 2.5	2.0	1.100	20	200
	3.0	1.250	24	200

► (S-40) Performans Çizelgesi

Nozzle (mm)	Basınç (Bar)	Debi (m ³ /saat)	Çap (m)	Koli Adet
2.8 x 1.8	2.0	0.600	20	150
	3.0	0.800	24	150
3.5 x 2.5	2.0	1.100	20	150
	3.0	1.250	24	150



446 (S-40)
49,15 ₺



445 (S-60 Plus)
84,00 ₺

► (S-60) Performans Çizelgesi

Nozzle (mm)	Basınç (Bar)	Debi (m ³ /saat)	Çap (m)	Koli Adet
3.8 x 2.3	2.5	1.280	20	50
	3.5	1.680	24	50
5.0 x 4.0	2.5	1.770	20	50
	3.5	2.110	24	50
4.2 x 3.5	2.5	1.575	20	50
	3.5	1.975	24	50

► (S-60) Performans Çizelgesi

Nozzle (mm)	Basınç (Bar)	Debi (m ³ /saat)	Çap (m)	Koli Adet
3.8 x 2.3	2.5	1.280	20	50
	3.5	1.680	24	50
5.0 x 4.0	2.5	1.770	20	50
	3.5	2.110	24	50
4.2 x 3.5	2.5	1.575	20	50
	3.5	1.975	24	50



443 (S-60)
84,00 ₺

► SPRİNKLER



447 (S-50)
75,60 ₺

► (S-50) Küçük Açılı Performans Çizelgesi

Nozzle (mm)	Basınç (Bar)	Debi (m ³ /saat)	Çap (m)	Koli Adet
2.8 x 00	2.0	0.600	22	150
	3.0	0.800	25	150
3.5 x 00	2.0	1.100	22	150
	3.0	1.250	25	150

► (S-80) Performans Çizelgesi

Nozzle (mm)	Basınç (Bar)	Debi (m ³ /saat)	Çap (m)	Koli Adet
3.8 x 2.3	2.5	1.195	22	50
	3.5	1.430	25	50
5.0 x 4.0	2.5	2.410	22	50
4.2 x 3.5	3.5	2.895	25	50



440 (S-80)
86,00 ₺



441 (S-70)
103,00 ₺

► (S-70) Performans Çizelgesi

Nozzle (mm)	Basınç (Bar)	Debi (m ³ /saat)	Çap (m)	Koli Adet
3.8 x 00	2.5	1.620	22	50
	3.5	1.870	25	50
4.2 x 00	2.5	2.110	22	50
	3.5	2.490	25	50

► (S-90) Performans Çizelgesi

Nozzle (mm)	Basınç (Bar)	Debi (m ³ /saat)	Çap (m)	Koli Adet
3.8 x 2.3	2.5	1.620	20	50
	3.5	1.870	24	50
4.2 x 3.5	2.5	1.200	20	50
	3.5	1.450	24	50
5.0 x 4.0	2.5	2.110	20	50
	3.5	2.490	24	50

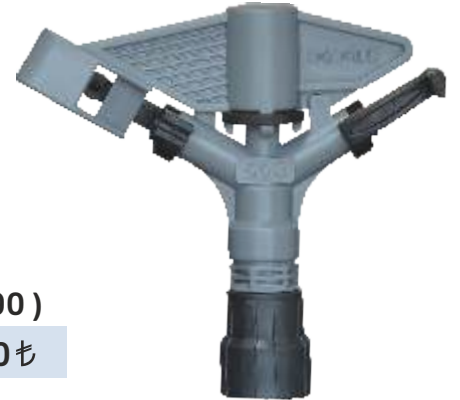

448 (S-90)
111,00 ₺



442 (S-60)
86,00 ₺

► (S-60) Performans Çizelgesi

Nozzle (mm)	Basınç (Bar)	Debi (m ³ /saat)	Çap (m)	Koli Adet
3.8 x 2.3	2.5	1.280	20	50
	3.5	1.680	24	50
5.0 x 4.0	2.5	1.770	20	50
	3.5	2.110	24	50
4.2 x 3.5	2.5	1.575	20	50
	3.5	1.975	24	50

▶ **MANDALLI YAĞMURLAMA BORUSU / LANDING LUBRICATION PIPE**



MANDALLI BORU 5 METRE - 6 ATÜ

Ürün Kod	(Q) Çap-mm	Fiyat/Adet ₺
700	50	196,15
701	63	243,39
702	75	315,00
703	90	447,30
704	110	774,90
705	125	1.153,00
706	140	1.600,00
707	160	2.031,00

MANDALLI BORU 5.60 METRE - 6 ATÜ

Ürün Kod	(Q) Çap-mm	Fiyat/Adet ₺
722	90	484,00
723	110	844,00
724	125	1.242,40

MANDALLI BORU 6 METRE - 6 ATÜ

Ürün Kod	(Q) Çap-mm	Fiyat/Adet ₺
708	50	211,10
709	63	269,85
710	75	367,90
711	90	524,40
712	110	963,00
713	125	1.372,60
714	140	1.905,00
715	160	2.373,000

▶ **MANDALLI YAĞMURLAMA BORUSU / LANDING LUBRICATION PIPE**



MANDALLI BORU 5 METRE - 8 ATÜ

Ürün Kod	(Q) Çap-mm	Fiyat/Adet ₺
8100	75	446,77
8101	90	651,00
8102	110	1.083,00
8103	125	1.467,00
8104	140	1.927,00
8105	160	2.351,00

MANDALLI BORU 6 METRE - 8 ATÜ

Ürün Kod	(Q) Çap-mm	Fiyat/Adet ₺
8106	75	516,00
8107	90	740,00
8108	110	1.250,00
8109	125	1.688,00
8110	140	2.215,00
8111	160	2.847,00

▶ **HDP PE 100 YER ALTI BORULARI / HDP PE 100 UNDERGROUND PIPES**



HDPE PE 100 BORU PN - 8 ATÜ

Ürün Kod	(Q) Çap-mm	Fiyat/Mt. ₺
8112	110	215,00
8113	125	275,00
8114	140	343,00
8115	160	449,00

HDPE PE 100 BORU PN - 10 ATÜ

Ürün Kod	(Q) Çap-mm	Fiyat/Mt. ₺
8117	110	262,50
8118	125	335,60
8119	140	419,25
8120	160	546,00

► PE MANDALLI EK PARÇALARI / PE LATCH FITTINGS

► DİRSEK / ELBOW



Ürün Kod	(Q) Çap-mm	Fiyat/Adet ₺
087	50	113,90
088	63	123,30
089	75	148,00
090	90	200,00
091	110	292,30
092	125	513,00
093	140	731,20
094	160	845,25

► ABOT / ABOT



Ürün Kod	(Q) Çap-mm	Fiyat/Adet ₺
082	50	51,45
083	63	56,70
084	75	91,15
085	90	125,75
086	110	158,50

► TE / TE



Ürün Kod	(Q) Çap-mm	Fiyat/Adet ₺
001	50x50	144,15
002	63x50	147,85
003	63x63	150,85
004	75x50	176,15
005	75x63	178,00
006	75x75	182,25
007	90x50	215,25
008	90x63	217,35
009	90x75	222,50
010	90x90	239,00
011	110x50	311,50
012	110x63	314,70
013	110x75	319,85
014	110x90	337,15
015	110x110	378,85
016	125x50	517,35
017	125x63	517,85
018	125x75	525,25

Ürün Kod	(Q) Çap-mm	Fiyat/Adet ₺
019	125x90	543,60
020	125x110	585,40
021	125x125	625,20
722	140x50	651,75
723	140x63	653,25
022	140x75	658,70
023	140x90	738,50
024	140x110	782,75
025	140x125	816,85
026	140x140	886,90
0260	160x63	823,85
027	160x75	828,50
028	160x90	846,20
029	160x110	889,15
030	160x125	919,50
031	160x140	990,75
032	160x160	1.015,00

► İSTAVROZ / SPIDER (CROSS)



Ürün Kod	(Q) Çap-mm	Fiyat/Adet ₺
033	50x50	167,35
034	63x50	170,75
035	63x63	174,60
036	75x50	196,85
037	75x63	203,50
038	75x75	210,00
039	90x50	238,50
040	90x63	242,85
041	90x75	251,70
042	90x90	285,50
043	110x50	336,70
044	110x63	340,75
045	110x75	352,25
046	110x90	385,50
047	110x110	471,75
048	125x50	545,80
049	125x63	551,20

Ürün Kod	(Q) Çap-mm	Fiyat/Adet ₺
050	125x75	559,15
051	125x90	597,00
052	125x110	681,75
053	125x125	758,85
724	140x50	751,75
725	140x63	753,25
054	140x75	754,50
055	140x90	795,85
056	140x110	885,60
057	140x125	948,50
058	140x140	1.085,70
0580	160x63	856,85
059	160x75	866,25
060	160x90	899,65
061	160x110	987,25
062	160x125	1.052,95
063	160x140	1.188,60
064	160x160	1.232,70

ERKEK BAŞLIK / MALE HEAD

Ürün Kod	(Q) Çap-mm	Fiyat/ ₺	Paket
104	50	28,85	250
105	63	29,65	200
106	75	43,25	100
107	90	56,15	70
108	110	82,85	50
109	125	224,70	30
110	140	270,30	20
111	160	342,95	15

DİŞİ BAŞLIK / FEMALE HEAD

Ürün Kod	(Q) Çap-mm	Fiyat/ ₺	Paket
112	50	18,35	250
113	63	19,85	200
114	75	23,85	100
115	90	39,85	70
116	110	80,50	50
117	125	113,10	30
118	140	180,50	20
119	160	198,34	15

REDÜKSİYON / REDUCTION

Ürün Kod	(Q) Çap-mm	Fiyat/ ₺	Paket
065	63x50	108,60	50
066	75x50	115,50	30
067	75x63	117,90	25
068	90x50	134,00	30
069	90x63	136,40	30
070	90x75	142,25	30
071	110x75	185,75	20
072	110x90	205,50	20
073	125x75	340,00	15



Ürün Kod	(Q) Çap-mm	Fiyat/ ₺	Paket
074	125x90	354,25	12
075	125x110	404,75	12
076	140x90	448,15	11
077	140x110	498,25	10
078	140x125	533,70	10
079	160x110	584,15	10
080	160x125	620,25	9
081	160x140	690,00	7

ERKEK KÖR TAPA / MALE BLIND PLUG

Ürün Kod	(Q) Çap-mm	Fiyat/ ₺	Paket
120	50	30,45	100
121	63	31,80	100
122	75	45,95	100
123	90	62,05	70
124	110	88,20	50
125	125	232,95	30
126	140	279,25	20
127	160	354,85	15

DİŞİ KÖR TAPA / FEMALE BLIND PLUG

Ürün Kod	(Q) Çap-mm	Fiyat/ ₺	Paket
128	50	18,35	100
129	63	20,85	100
130	75	25,50	100
131	90	44,80	70
132	110	83,70	50
133	125	111,90	30
134	140	183,50	20
135	160	202,75	15

ES / ES

Ürün Kod	(Q) Çap-mm	Fiyat/Adet ₺
137	75	390,00
138	90	510,30
139	110	675,80

MANDALLI CONTA / LATCH WASHER (GASKET)

Ürün Kod	(Q) Çap-mm	Fiyat/ ₺	Paket
556	50	3,45	4,000
557	63	4,10	2,000
558	75	6,10	1,000
559	90	9,30	1,000
560	110	12,00	800
561	125	21,40	500
562	140	32,60	400
563	160	36,20	250



► PE KELEPÇELİDEN MANDALLIYA GEÇİŞ / PE CLAMP LATCH FITTINGS

► İSTAVROZ / SPIDER (CROSS)



Ürün Kod	(Q) Çap-mm	Fiyat/Adet ₺
508	75x50	340,85
509	75x63	348,50
510	75x75	372,75
511	90x50	435,85
512	90x63	438,50
513	90x75	448,85
514	90x90	491,00
515	110x50	932,40
516	110x63	937,00
517	110x75	949,85
518	110x90	987,60
519	110x110	1.084,85
520	125x50	1.210,15
521	125x63	1.221,35
522	125x75	1.231,85
523	125x90	1.271,90

Ürün Kod	(Q) Çap-mm	Fiyat/Adet ₺
524	125x110	1.367,00
525	125x125	1.445,00
730	140x50	1.547,15
731	140x63	1.548,75
526	140x75	1.549,00
527	140x90	1.593,85
528	140x110	1.695,00
529	140x125	1.766,85
530	140x140	1.922,25
0530	160x63	1.725,75
531	160x75	1.728,50
532	160x90	1.767,85
533	160x110	1.866,75
534	160x125	1.941,50
535	160x140	2.094,85
536	160x160	2.144,00

► TE / TE



Ürün Kod	(Q) Çap-mm	Fiyat/Adet ₺
479	75x50	316,70
480	75x63	319,60
481	75x75	324,50
482	90x50	407,75
483	90x63	410,25
484	90x75	416,00
485	90x90	434,75
486	110x50	906,85
487	110x63	910,00
488	110x75	916,45
489	110x90	935,85
490	110x110	983,15
491	125x50	1.181,70
492	125x63	1.185,25
493	125x75	1.191,50
494	125x90	1.212,00

Ürün Kod	(Q) Çap-mm	Fiyat/Adet ₺
495	125x110	1.260,50
496	125x125	1.298,75
732	140x50	1.499,50
733	140x63	1.500,00
497	140x75	1.507,85
498	140x90	1.532,25
499	140x110	1.582,00
500	140x125	1.621,50
501	140x140	1.698,85
0501	160x63	1.686,50
502	160x75	1.690,75
503	160x90	1.710,40
504	160x110	1.758,95
505	160x125	1.793,75
506	160x140	1.873,50
507	160x160	1.901,85

► REDÜKSİYON / REDUCTION



Ürün Kod	(Q) Çap-mm	Fiyat/Adet ₺
467	90x75	187,95
468	110x75	808,50
469	110x90	829,75
470	125x75	1.031,50
471	125x90	1.047,85
472	125x110	1.104,75

Ürün Kod	(Q) Çap-mm	Fiyat/Adet ₺
473	140x90	1.259,85
474	140x110	1.315,50
475	140x125	1.355,00
476	160x110	1.464,50
477	160x125	1.505,25
478	160x140	1.584,50

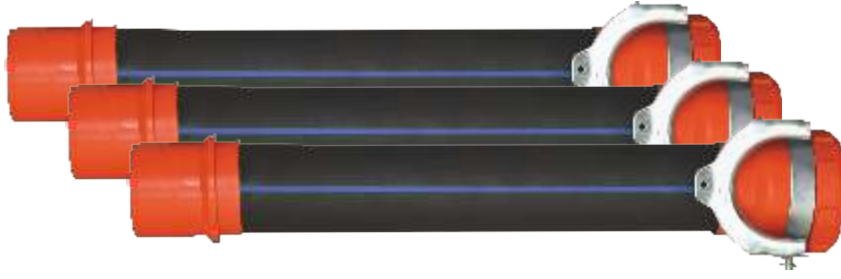
▶ KELEPÇELİ YAĞMURLAMA BORUSU / CLIPPING SPRINKLING PIPE

KELEPÇELİ BORU 5 METRE - 6 ATÜ

Ürün Kod	(Q) Çap-mm	Fiyat/Adet ₺
716	75	443,25
717	90	592,85
718	110	1.310,80
719	125	1.721,50
720	140	2.203,75
721	160	2.684,85

▶ REDÜKSİYON / REDUCTION

Ürün Kod	(Q) Çap-mm	Fiyat/ ₺	Paket
190	90x75	297,85	23
191	110x75	869,50	13
192	110x90	914,75	10
193	125x75	1.169,25	10
194	125x90	1.203,50	10
195	125x110	1.078,50	10

Ürün Kod	(Q) Çap-mm	Fiyat/ ₺	Paket
196	140x90	1.414,00	10
197	140x110	1.289,00	9
198	140x125	1.314,50	9
199	160x110	1.438,50	8
200	160x125	1.464,25	8
201	160x140	1.532,00	8

▶ ERKEK BAŞLIK / MALE HEAD

Ürün Kod	(Q) Çap-mm	Fiyat/ ₺	Paket
221	75	143,85	70
222	90	185,15	45
223	110	59,85	30
224	125	80,30	30
225	140	140,70	20
226	160	160,50	15

▶ DIŞI BAŞLIK / FEMALE HEAD

Ürün Kod	(Q) Çap-mm	Fiyat/ ₺	Paket
227	75	42,30	70
228	90	57,25	45
229	110	620,00	30
230	125	795,85	30
231	140	970,75	20
232	160	1.097,50	15

▶ DIŞI KÖR TAPA / FEMALE BLIND PLUG

Ürün Kod	(Q) Çap-mm	Fiyat/ ₺	Paket
233	75	46,75	70
234	90	63,30	40
235	110	633,50	40
236	125	810,00	30
237	140	985,00	15
238	160	1.110,00	15

▶ KELEPÇE / CLAMP

Ürün Kod	(Q) Çap-mm	Fiyat/ ₺
549	75	77,85
550	90	99,50
551	110	504,00
552	125	628,50
553	140	743,50
554	160	849,75

▶ MANDAL-PERÇİN-YAY / SEKMEN

Ürün Kod	(Q) Çap-mm	Fiyat/ ₺	Paket
591	63	16,75	200
592	75	20,50	200
593	110	25,35	200
594	125	50,75	200

▶ SEKMEN / SEKMEN

Ürün Kod	Fiyat/Adet ₺	Paket
555	5,85	1.000

► PE KELEPÇELİ EK PARÇALARI / PE CLAMP-ON FITTINGS

► DİRSEK / ELBOW



Ürün Kod	(Q) Çap-mm	Fiyat/Adet ₺
205	75	276,15
206	90	347,20
207	110	822,80
208	125	1.065,00
209	140	1.402,00
210	160	1.573,00

► ABOT / ABOT



Ürün Kod	(Q) Çap-mm	Fiyat/Adet ₺
202	75	200,00
203	90	246,50
204	110	662,85

► TE / TE



Ürün Kod	(Q) Çap-mm	Fiyat/Adet ₺
148	75x75	477,35
149	90x75	547,75
150	90x90	593,50
151	110x75	1.048,25
152	110x90	1.094,50
153	110x110	962,85
154	125x75	1.320,00
155	125x90	1.367,85
156	125x110	1.237,50
157	125x125	1.257,85
158	140x75	1.635,25

Ürün Kod	(Q) Çap-mm	Fiyat/Adet ₺
159	140x90	1.685,25
160	140x110	1.552,95
161	140x125	1.577,25
162	140x140	1.645,85
163	160x75	1.816,25
164	160x90	1.862,75
165	160x110	1.729,00
166	160x125x	1.750,25
167	160x140	1.818,60
168	160x160	1.848,00

► İSATAVROZ / SPIDER (CROSS)



Ürün Kod	(Q) Çap-mm	Fiyat/Adet ₺
169	75x75	632,75
170	90x75	706,65
171	90x90	804,00
172	110x75	1.213,85
173	110x90	1.304,50
174	110x110	1.047,50
175	125x75	1.489,25
176	125x90	1.583,00
177	125x110	1.315,00
178	125x125	1.362,85
179	140x75	1.804,50

Ürün Kod	(Q) Çap-mm	Fiyat/Adet ₺
180	140x90	1.905,15
181	140x110	1.642,85
182	140x125	1.684,60
183	140x140	1.818,20
184	160x75	1.986,50
185	160x90	2.078,50
186	160x110	1.814,40
187	160x125	1.859,50
188	160x140	1.991,85
189	160x160	2.043,70

► ES / ES



Ürün Kod	(Q) Çap-mm	Fiyat/Adet ₺
218	75	576,50
219	90	733,00
220	110	1.306,00

► KELEPÇELİ CONTA / CLAMP WASHER (GASKET)



Ürün Kod	(Q) Çap-mm	Fiyat/ ₺	Paket
430	75	7,00	1.000
431	90	10,70	1.000
432	110	13,80	800
433	125	24,60	500
434	140	37,50	400
435	160	41,60	250

▶ MANDALLI HAT VANA KÜRESEL / LINE VALVES



Ürün Kod (Q)	Çap-mm	Fiyat/Adet ₺
095	50	215,00
096	63	264,50
097	75	313,85
098	90	507,00
099	110	867,50



▶ KELEPÇELİ HAT VANA / LINE VALVES



Ürün Kod (Q)	Çap-mm	Fiyat/Adet ₺
211	75	1.115,00
212	90	1.264,00
213	110	2.412,00
214	125	2.731,00
215	140	3.688,00
216	160	4.275,00

▶ MANDALLI HAT VANA KELEBEK / LINE VALVES

Ürün Kod (Q)	Çap-mm	Fiyat/Adet ₺
580	75	451,85
581	90	673,50
582	110	1.049,50
100	125	1.719,00
101	140	2.850,00
102	160	3.995,00

▶ KELEPÇELİDEN MANDALLIYA GEÇİŞ /



Ürün Kod (Q)	Çap-mm	Fiyat/Adet ₺
564	75x75	154,95
565	90x90	212,80
566	110x110	847,30
567	125x125	1.085,00
568	140x140	1.375,00
569	160x160	1.543,00

▶ MANDALLIDAN KELEPÇELİYE GEÇİŞ /



Ürün Kod (Q)	Çap-mm	Fiyat/Adet ₺
570	75x75	277,25
571	90x90	357,80
572	110x110	289,80
573	125x125	486,15
574	140x140	638,75
575	160x160	759,35

▶ YERALTI DIŞI ERKEK ÇIKIŞ TE



Ürün Kod	(Q) Çap-mm	Fiyat/Adet ₺
2018	160X110	703,50
2019	160X125	787,50
2020	160X140	808,50
2021	160X160	955,50

▶ YER ALTI BORULARI



Ürün Kod (Q)	Çap-mm	Fiyat/Adet ₺
2026	75	156,25
2027	90	187,50
2028	110	381,20
2029	125	410,00
2030	140	601,00
2031	160	739,35

▶ YERALTI ERKEK ERKEK ÇIKIŞ TE



Ürün Kod	(Q) Çap-mm	Fiyat/Adet ₺
2005	160X75	514,00
2006	160X90	544,85
2007	160X110	573,00
2008	160X125	604,75
2009	160X140	688,00
2010	160X160	707,00

▶ YERALTI GİRİŞ



Ürün Kod	(Q) Çap-mm	Fiyat/Adet ₺
2032	140	1.180,00
2033	160	1.302,00

► **DAMLAMA SULAMA BORULARI / DRIP IRRIGATION PIPES**



► **17 mm YASSI DAMLAMA SULAMA BORUSU / FLAT DRIP IRRIGATION PIPES**

Ürün Kod	(Q) Çap-mm	Kalınlık	Rulo Uzunluk	20 cm	25 cm	30 cm	33 cm	40 cm	50 cm
813	17 mm	06 mil							Fiyat Alınız
814	17 mm	08 mil							Fiyat Alınız
815	17 mm	10 mil							Fiyat Alınız
816	17 mm	12 mil							Fiyat Alınız
817	17 mm	18 mil							Fiyat Alınız

► **22 mm YASSI DAMLAMA SULAMA BORUSU / FLAT DRIP IRRIGATION PIPES**

Ürün Kod	(Q) Çap-mm	Kalınlık	Rulo Uzunluk	20 cm	25 cm	30 cm	40 cm	50 cm	60 cm
818	22 mm	12 mil							Fiyat Alınız
819	22 mm	15 mil							Fiyat Alınız
820	22 mm	18 mil							Fiyat Alınız

► **25 mm YASSI DAMLAMA SULAMA BORUSU / FLAT DRIP IRRIGATION PIPES**

Ürün Kod	(Q) Çap-mm	Kalınlık	Rulo Uzunluk	20 cm	25 cm	30 cm	40 cm	50 cm	60 cm
821	25 mm	13 mil	750 mt						Fiyat Alınız

► **16 mm YUVARLAK DAMLAMA SULAMA BORUSU / ROUND DRIP IRRIGATION PIPES**



Ürün Kod	(Q) Çap-mm	Kalınlık	Damlatıcı Aralığı	Uzunluk	Debi	Fiyat/Adet ₺
800	16 mm		20 cm	400 mt.		Fiyat Alınız
801	16 mm		25 cm	400 mt.		Fiyat Alınız
802	16 mm		33 cm	400 mt.		Fiyat Alınız
803	16 mm		40 cm	400 mt.		Fiyat Alınız
804	16 mm		50 cm	400 mt.		Fiyat Alınız

► **20 mm YUVARLAK DAMLAMA SULAMA BORUSU / ROUND DRIP IRRIGATION PIPES**



Ürün Kod	(Q) Çap-mm	Kalınlık	Damlatıcı Aralığı	Uzunluk	Debi	Fiyat/Adet ₺
805	20 mm		20 cm	300 mt.		Fiyat Alınız
806	20 mm		25 cm	300 mt.		Fiyat Alınız
807	20 mm		33 cm	300 mt.		Fiyat Alınız
808	20 mm		40 cm	300 mt.		Fiyat Alınız
809	20 mm		50 cm	300 mt.		Fiyat Alınız

► **YUVARLAK PE DAMLAMA SULAMA BORUSU / ROUND DRIP IRRIGATION PIPES**



Ürün Kod	(Q) Çap-mm	Kalınlık	Damlatıcı Aralığı	Uzunluk	Debi	Fiyat/Adet ₺
810	16 mm		-	400 mt.	-	Fiyat Alınız
811	20 mm		-	300 mt.	-	Fiyat Alınız
812	25 mm		-	200 mt.	-	Fiyat Alınız

► KÜRESEL VANA / SPHERICAL VALVE

Ürün Kod (Q)	Çap-mm	Fiyat/ ₺	Paket
412	32x32	25,20	100

► ERKEK VANA / MALE VALVE

Ürün Kod (Q)	Çap-mm	Fiyat/ ₺	Paket
413	32x32	25,20	100

► ABOT ÜSTÜ İSTAVROZ / ABOT THE SIGN OF THE CROSS OVER

Ürün Kod (Q)	Çap-mm	Fiyat/ ₺	Paket
414	32x20x20	16,15	125

► VİDALI MİNİ SPRİNG ADAPTÖRÜ / SCREW ADAPTER MINI SPRINK

Ürün Kod (Q)	Çap-mm	Fiyat/ ₺	Paket
136	20x20x20	8,10	500

► DEMİR ÇUBUK / IRON BAR

Ürün Kod (Q)	Çap-mm	Fiyat/Adet ₺
499	8x80	Fiyat Alınız
500	8x100	Fiyat Alınız
501	8x120	Fiyat Alınız

► PVC UZATMA BORU (BEYAZ) / EXTENSION PIPE WHITE

Ürün Kod (Q)	Çap-mm	Fiyat/ ₺	Paket
424	32x25	11,55	200
425	32x35	16,00	150
426	32x50	23,00	100
427	32x60	27,50	100
428	32x75	34,30	100
429	32x100	45,80	100

► KARIK SULAMA VANASI / FURROW IRRIGATION VALVE

Ürün Kod (Q)	Çap-mm	Fiyat/ ₺	Paket
416		16,90	500

► NİPEL / NİPEL

Ürün Kod (Q)	Çap-mm	Fiyat/ ₺	Paket
415	32x32	6,50	500
N-416	32x25	6,40	500
N-417	32x20	6,30	500

► PVC UZATMA BORU BEYAZ (ORJİNAL) / EXTENSION PIPE BLUE

Ürün Kod (Q)	Çap-mm	Fiyat/ ₺	Paket
418	32x25	14,45	200
419	32x35	20,20	150
420	32x50	27,95	100
421	32x60	32,57	100
422	32x75	42,45	100
423	32x100	51,60	100

► MAŞON / SLEEVE

Ürün Kod (Q)	Çap-mm	Fiyat/ ₺	Paket
409	32x20	6,30	500
410	32x25	6,30	500
411	32x32	8,70	500

► ABOT MAŞON / ABOT SLEEVE

Ürün Kod (Q)	Çap-mm	Fiyat/ ₺	Paket
408	32x40	8,70	500

► PE UZATMA / PE EXTENSION PIPE

Ürün Kod (Q)	Çap-mm	Fiyat/ ₺	Paket
417	32x25	20,00	100

POMPA ÇIKIŞLARI / LATCH PUMP OUTPUT
▶ PLASTİK ERKEK MANDALLI POMPA ÇIKIŞI / PLASTIC MALE LATCH PUMP OUTPUT

Ürün Kod	(Q) Çap-mm	Fiyat/Adet ₺
289	63	164,25
290	75	267,85
291	90	354,50
292	110	462,70
293	125	667,50
294	140	836,50
295	160	945,00

▶ PLASTİK DIŞI MANDALLI POMPA ÇIKIŞI / PLASTIC FEMALE PUMP OUTPUT

Ürün Kod	(Q) Çap-mm	Fiyat/Adet ₺
296	63	143,85
297	75	221,15
298	90	323,25
299	110	416,50
300	125	626,50
301	140	709,00
302	160	842,75

▶ PLASTİK ERKEK MANDALLI POMPA ÇIKIŞI / PLASTIC MALE LATCH PUMP OUTPUT

Ürün Kod	(Q) Çap-mm	Fiyat/Adet ₺
285	50	82,50
286	63	97,50
287	75	123,75
288	90	174,85

▶ PLASTİK DIŞI MANDALLI POMPA ÇIKIŞI / PLASTIC FEMALE PUMP OUTPUT

Ürün Kod	(Q) Çap-mm	Fiyat/Adet ₺
279	50	46,85
280	63	67,70
281	75	82,15
282	90	138,85

▶ ERKEK MANDALLI POMPA ÇIKIŞI / MALE LATCH PUMP OUTPUT

Ürün Kod	(Q) Çap-mm	Fiyat/Adet ₺
311	50	308,25
312	63	309,85
313	75	374,00
314	90	396,75
315	110	440,50
316	125	726,00
317	140	990,00
318	160	1.110,50

▶ DIŞI MANDALLI POMPA ÇIKIŞI / FEMALE LATCH PUMP OUTPUT

Ürün Kod	(Q) Çap-mm	Fiyat/Adet ₺
303	50	242,25
304	63	243,85
305	75	264,75
306	90	286,50
307	110	374,85
308	125	539,50
309	140	770,85
310	160	968,50

▶ ERKEK MANDALLI POMPA ÇIKIŞI / MALE LATCH PUMP OUTPUT

Ürün Kod	(Q) Çap-mm	Fiyat/Adet ₺
271	50	262,25
272	63	318,00
273	75	372,00
274	90	469,75
275	110	579,15
276	125	1.048,50
277	140	1.725,50
278	160	1.745,00

▶ DIŞI MANDALLI POMPA ÇIKIŞI / FEMALE LATCH PUMP OUTPUT

Ürün Kod	(Q) Çap-mm	Fiyat/Adet ₺
263	50	208,00
264	63	248,75
265	75	303,60
266	90	386,40
267	110	510,75
268	125	855,50
269	140	1.415,75
270	160	1.428,50

▶ DEMİR MAŞON / Iron Sleeve

Ürün Kod	(Q) Çap-mm	Fiyat/Adet ₺
596	1/2x50	89,75
597	2/2x63	149,85
598	3/2x75	198,00
599	4/2x90	253,50
560	5/2x110	396,00
561	6/2x125	528,50

▶ SÜZGEÇ KLEPE / FEMALE CLAMP PUMP OUTPUT

Ürün Kod	(Q) Çap-mm	Fiyat/Adet ₺
562	75	1.145,25
563	90	1.215,15
564	110	1.760,15
565	125	2.090,00
566	160	2.200,00
567	200	5.500,00

► YÜZÜKLÜ MİNİ VANA / Ringed Mini Valve

Ürün Kod	(Q) Çap-mm	Fiyat/₺	Koli
826	17x17	10,75	200
827	22x22	11,50	175
828	25x25	18,75	100

► YÜZÜKLÜ CONTA ÇIKIŞ MİNİ VANA / Ringed Gasket Out Mini Valve

Ürün Kod	(Q) Çap-mm	Fiyat/₺	Koli
829	16x17	9,00	225
830	22x20	10,25	200
831	25x20	17,75	125

► YÜZÜKLÜ DIŞ DIŞLI MİNİ VANA / Ringed Male Threaded Mini Valve

Ürün Kod	(Q) Çap-mm	Fiyat/₺	Koli
838	1/2x17	6,15	225
839	3/4x17	6,95	225
840	1/2x22	7,10	250
841	3/4x22	7,30	200

► SOMUNLU DIŞ DIŞLI MİNİ VANA / Bolt Nut Male Threaded Mini Valve

Ürün Kod	(Q) Çap-mm	Fiyat/₺	Koli
848	1/2x17	6,40	225
849	3/4x17	7,20	200
850	1/2x22	7,95	175
851	3/4x22	8,30	175

► SOMUNLU MİNİ VANA / Bolt Nut Mini Valve

Ürün Kod	(Q) Çap-mm	Fiyat/₺	Koli
832	17x17	13,75	175
833	22x22	16,50	150
834	25x25	17,50	100

► SOMUNLU CONTA ÇIKIŞ MİNİ VANA / Bolt Nut Gasket Out Mini Valve

Ürün Kod	(Q) Çap-mm	Fiyat/₺	Koli
845	16x17	9,95	200
846	20x22	10,75	175
847	20x25	27,00	125

► KURTAĞZI MİNİ VANA / Indented Mini Valve

Ürün Kod	(Q) Çap-mm	Fiyat/₺	Koli
842	16x16	8,85	250
843	20x16	9,35	200
844	20x20	9,50	200

► KURTAĞZI CONTA ÇIKIŞ MİNİ VANA / Indented Gasket Out Mini Valve

Ürün Kod	(Q) Çap-mm	Fiyat/₺	Koli
835	16x16	8,75	250
836	20x20	9,50	200
837	20x25	14,00	125

► KURTAĞZI DIŞ DIŞLI MİNİ VANA / Indented Male Threaded in Mini Valve

Ürün Kod	(Q) Çap-mm	Fiyat/₺	Koli
852	16x1/2	9,75	225
853	16x3/4	9,75	225
854	20x1/2	10,50	225
855	20x3/4	10,50	225

► KURTAĞZI EKLEME NİPELİ / Indented Adding Nipple

Ürün Kod	(Q) Çap-mm	Fiyat/₺	Koli
856	16x16	1,65	1.300
857	20x16	1,85	800
858	20x20	1,90	800

► KURTAĞZI TE / Indented Te

Ürün Kod	(Q) Çap-mm	Fiyat/₺	Koli
859	16x16x16	2,75	700
861	20x16x20	2,95	500
862	20x20x20	3,25	450

► KURTAĞZI CONTA ÇIKIŞ EKLEME NİPELİ / Indented Gasket Out Adding Nipple

Ürün Kod	(Q) Çap-mm	Fiyat/₺	Koli
863	16x16	1,75	1.300
865	20x20	1,85	800

► KURTAĞZI DİRSEK / Indented Elbow

Ürün Kod	(Q) Çap-mm	Fiyat/₺	Koli
866	16x16	1,55	1.300
867	20x20	1,85	800

► KURTAĞZI KÖRTAPA /

Ürün Kod	(Q) Çap-mm	Fiyat/₺	Koli
868	16 mm	1,25	1.500
869	20 mm	1,65	1.000

► CONTA / MALE LATCH PUMP OUTPUT

Ürün Kod	(Q) Çap-mm	Fiyat/₺	Koli
870	16	1,60	1.000
871	20	2,00	1.000

► CONTA / MALE LATCH PUMP OUTPUT

Ürün Kod	(Q) Çap-mm	Fiyat/₺	Koli
872	16	1,30	1.000
873	20	1,65	1.000

► **DAMLAMA EK PARAÇALARI / DRIP FITTINGS**

► **CONTA TAPA / MALE LATCH PUMP OUTPUT**



Ürün Kod	(Q) Çap-mm	Fiyat/ ₺	Koli
872	16	1,45	1.000
873	20	1,85	1.000

► **SOMUNLU CONTA ÇIKIŞ EKLEME NİPELİ / Bolt Nut Gasket Out Adding Nipple**



Ürün Kod	(Q) Çap-mm	Fiyat/ ₺	Koli
879	16x17	2,75	600
880	20x22	3,50	400
881	20x25	4,85	300

► **YÜZÜKLÜ CONTA ÇIKIŞ EKLEME NİPELİ / Ringed Gasket Out Adding Nipple**



Ürün Kod	(Q) Çap-mm	Fiyat/ ₺	Koli
882	17x16	1,75	1.000
883	22x20	2,65	700
884	25x20	3,30	600

► **SOMUNLU CONTA ÇIKIŞLI TE / BoltNut Gasket Out T**



Ürün Kod	(Q) Çap-mm	Fiyat/ ₺	Koli
886	22x20x22	7,75	150

► **DIŞ DIŞLİ YÜZÜKLÜ TE / Outside with the ring gear T**



Ürün Kod	(Q) Çap-mm	Fiyat/ ₺	Koli
888	17x20x17	3,75	400
889	22x20x22	5,00	250
	25x20x25	5,85	200

► **CONTA ÇIKIŞLI YÜZÜKLÜ TE / Output With The Ring Gasket T**



Ürün Kod	(Q) Çap-mm	Fiyat/ ₺	Koli
890	17x16x17	3,75	400
891	17x20x17	3,75	400
892	22x20x22	5,00	250
893	25x20x25	5,85	200

► **SOMUNLU TE / Bolt Nut T**



Ürün Kod	(Q) Çap-mm	Fiyat/ ₺	Koli
894	20x20x20	9,75	150

► **YÜZÜKLÜ EKLEME NİPELİ / Ringed Adding Nipple**



Ürün Kod	(Q) Çap-mm	Fiyat/ ₺	Koli
895	17x17	2,10	750
896	22x22	3,05	500
897	25x25	4,15	400

► **DEBİ AYARLI DAMLATICI (BÜYÜK)/ Flow Adjustable Emitter (Big)**



Ürün Kod	(Q) Çap-mm	Fiyat/ ₺	Koli
898	0./100 lt.	1,15	2.000

► **DEBİ AYARLI DAMLATICI (KÜÇÜK)/ Flow Adjustable Emitter (Small)**



Ürün Kod	(Q) Çap-mm	Fiyat/ ₺	Koli
899	0./70 lt.	0,85	4.000

► **SOMUNLU EKLEME NİPELİ / Bolt Nut Adding Nipple**



Ürün Kod	(Q) Çap-mm	Fiyat/ ₺	Koli
876	17x17	2,95	500
877	22x22	3,45	350
878	25x25	5,85	200

► **YÜZÜKLÜ DIŞ DIŞ DİRSEK / External Teeth Elbow with Ring**



Ürün Kod	(Q) Çap-mm	Fiyat/ ₺	Koli
900	17x1/2	3,25	500
901	22x1/2	3,65	400
902	25x1/2	4,40	350

► **KLİPSLİ SABİTLEME KAZIĞI / Clipped Mounting Pile**



Ürün Kod	(Q) Çap-mm	Fiyat/ ₺	Koli
903	Kısa	1,75	300

► **BASINÇ AYARLI DAMLATICI / PC Dripper**



Ürün Kod	(Q) Çap-mm	Fiyat/ ₺	Koli
904	2 Lt/h	2,25	1.500
905	4 Lt/h	2,25	1.500
906	8 Lt/h	2,25	1.500
907	12 Lt/h	2,25	1.500

► **3 MM. DAMLAMA BORU DELME APARATI**



Ürün Kod	(Q) Çap-mm	Fiyat/ ₺	Koli
908	3 mm	27,00	100
909	8 mm	27,00	100

► **KANGAL BORU DELME APARATI / S Coil Pipe Drilling Apparatus**



Ürün Kod	(Q) Çap-mm	Fiyat/ ₺	Koli
910	16	35,00	100
911	20	35,00	100
912	32	40,00	100

TE / TE



Ürün Kod	(Q) Çap-mm	Fiyat/₺	Paket
319	63x50	47,50	100
320	63x63	50,30	70
321	75x50	61,15	80
322	75x63	62,75	100
323	75x75	63,25	100
324	90x50	69,90	60
325	96x63	70,80	60
326	90x75	71,80	60
327	90x90	73,65	60
328	110x50	92,70	45
329	110x63	93,65	45
330	110x75	95,30	45
331	110x90	97,20	40
332	110x110	98,75	40
333	125x50	111,60	35
334	125x63	112,80	35
335	125x75	116,95	35
336	125x90	118,15	30
337	125x110	119,30	30
338	125x125	126,20	20
726	140x50	165,00	25
727	140x63	166,00	25
339	140x75	168,00	35
340	140x90	174,30	35
341	140x110	175,45	25
342	140x125	182,50	30
343	140x140	203,70	30
0343	160x63	214,20	30
344	160x75	215,60	30
345	160x90	217,30	25
346	160x110	219,70	25
347	160x125	221,20	25
348	160x140	223,10	25
349	160x160	224,70	20

İSATAVROZ / SPIDER (CROSS)



Ürün Kod	(Q) Çap-mm	Fiyat/₺	Paket
350	63x50	49,60	100
351	63x63	52,30	100
352	75x50	64,40	80
353	75x63	68,30	80
354	75x75	69,40	80
355	90x50	77,15	60
356	96x63	78,60	50
357	90x75	81,50	50
358	90x90	83,15	45
359	110x50	98,70	40
360	110x63	99,85	40
361	110x75	104,50	40
362	110x90	105,85	35
363	110x110	110,75	35
364	125x50	122,65	35
365	125x63	123,30	30
366	125x75	122,15	30
367	125x90	124,40	25
368	125x110	127,35	25
369	125x125	138,40	25
728	140x50	198,00	25
729	140x63	200,00	25
370	140x75	201,20	25
371	140x90	210,50	30
372	140x110	219,00	25
373	140x125	221,00	25
374	140x140	223,00	25
0374	160x63	224,20	25
375	160x75	225,10	25
376	160x90	226,80	25
377	160x110	233,10	20
378	160x125	234,20	20
379	160x140	235,60	20
380	160x160	241,50	15

REDÜKSİYON / REDUCTION



Ürün Kod	(Q) Çap-mm	Fiyat/₺	Paket
389	75x50	37,80	100
390	75x63	38,50	100
391	90x50	39,65	100
392	90x63	41,20	100
393	90x75	42,35	100
394	110x75	54,60	50
395	110x90	58,40	50
396	125x75	76,25	40
397	125x90	76,00	40
398	125x110	84,40	40
399	140x90	91,60	30
400	140x110	102,90	30
401	140x125	104,60	30
402	160x110	115,10	40
403	160x125	118,60	35
404	160x140	120,95	30

DİRSEK / ELBOW

Ürün Kod	(Q) Çap-mm	Fiyat/₺	Paket
381	50	46,20	250
382	63	53,45	180
383	75	60,50	130
384	90	79,40	90
385	110	103,00	60
386	125	131,20	40
387	140	233,60	25
388	160	235,20	20

ES / ES

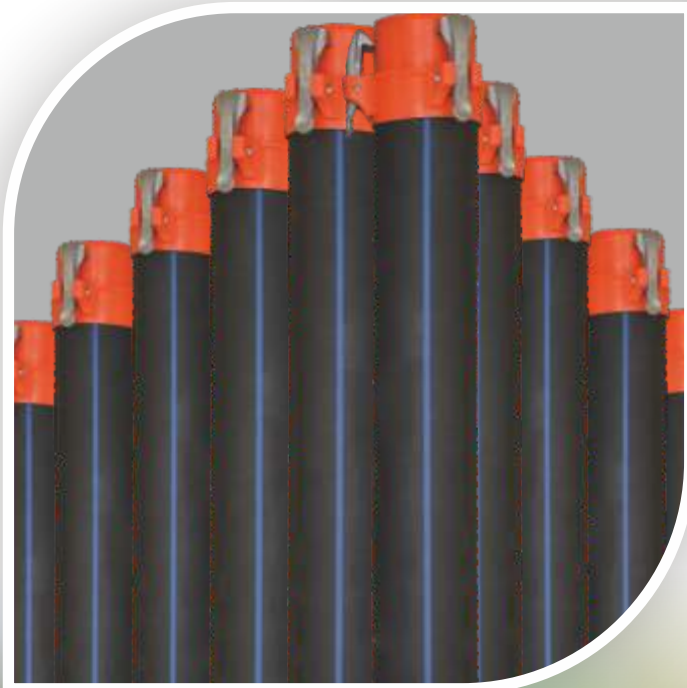
Ürün Kod	(Q) Çap-mm	Fiyat/₺	Paket
405	75	310,00	30
406	90	370,00	20
407	110	444,00	15





www.ugurluyagmurlama.com.tr

We Care About The World

 **UĞURLU**[®]
Yağmurlama ve Sulama Sistemleri

Toprağınıza Uğurlu
Bereketi Gelsin



 Başak Mahallesi Arabacı Sokak No: 3
Karatay / Konya / TÜRKİYE

 Tel : +90.332 342 41 82
Fax: +90.332 342 41 83

 bilgi@ugurluyagmurlama.com.tr
www.ugurluyagmurlama.com.tr



 **Online Katalok**